

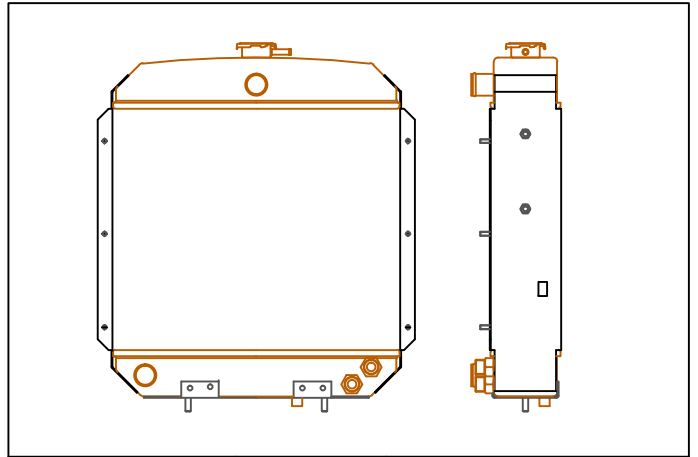

 Clancy Radiators Ltd.	REF No:	DS001
	MODEL No:	A-443511342109
	CORE SIZE	345 x 422
	CORE FORM	4 Row x 8 F.P.I.



 Clancy Radiators Ltd.	REF No:	DS002
	MODEL No:	A--443511424109
	CORE SIZE	To be Developed
	CORE FORM	To be Developed

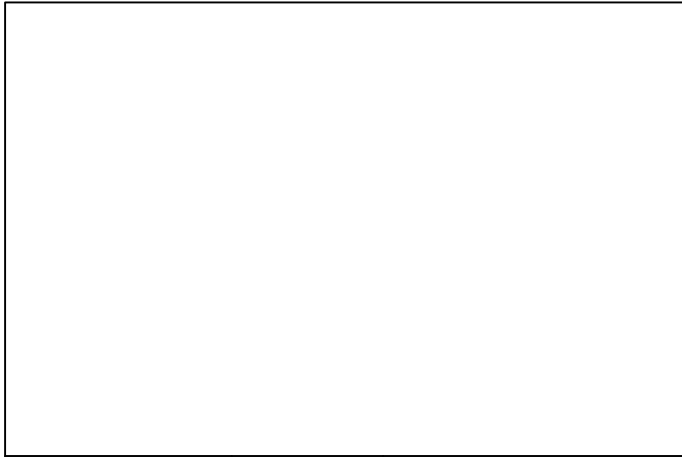

 Clancy Radiators Ltd.	REF No:	
	MODEL No:	
	CORE SIZE	
	CORE FORM	

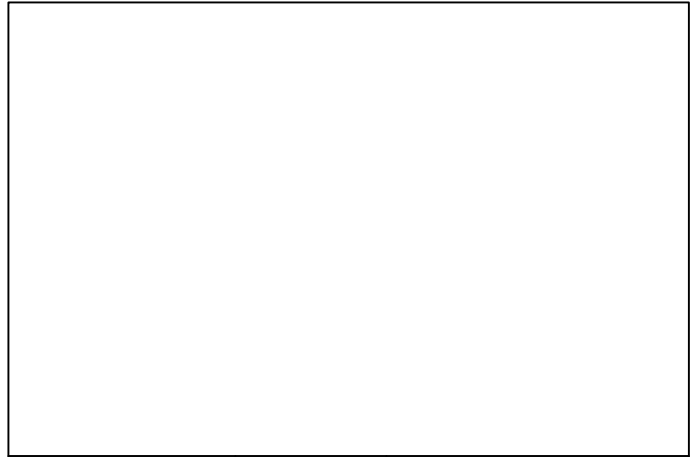

 Clancy Radiators Ltd.	REF No:	
	MODEL No:	
	CORE SIZE	
	CORE FORM	

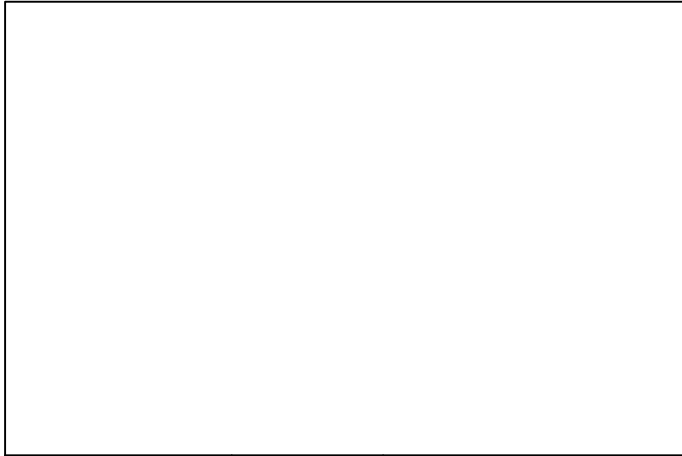

 Clancy Radiators Ltd.	REF No:	
	MODEL No:	
	CORE SIZE	
	CORE FORM	

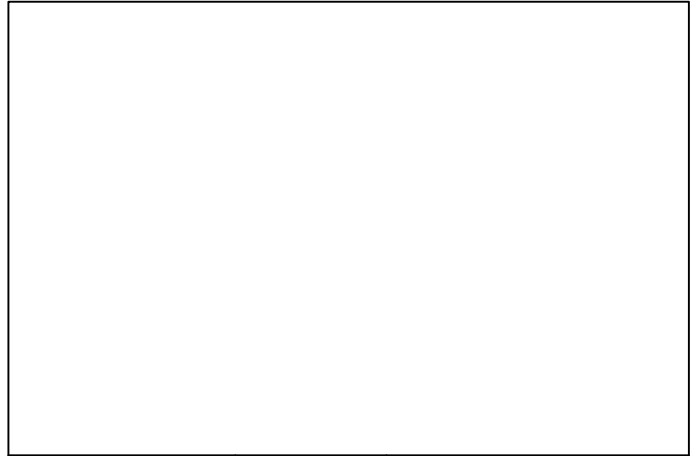

 Clancy Radiators Ltd.	REF No:	
	MODEL No:	
	CORE SIZE	
	CORE FORM	