

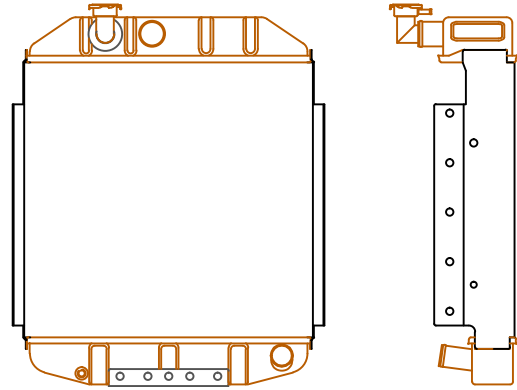

 Clancy Radiators Ltd.	REF No:	CH001
	MODEL No:	A-Chamberlin 306
	CORE SIZE	549 x 496
	CORE FORM	4 Row x 7 F.P.I.



 Clancy Radiators Ltd.	REF No:	CH002
	MODEL No:	Chamberlin
	CORE SIZE	493 x 496
	CORE FORM	4 Row x 8 F.P.I.

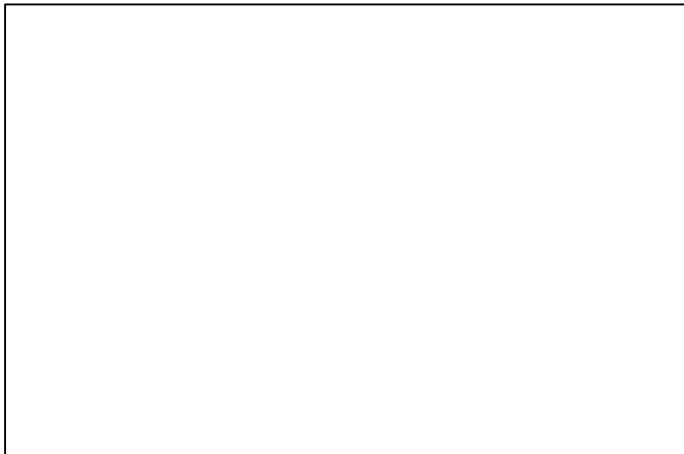

 Clancy Radiators Ltd.	REF No:	
	MODEL No:	
	CORE SIZE	
	CORE FORM	

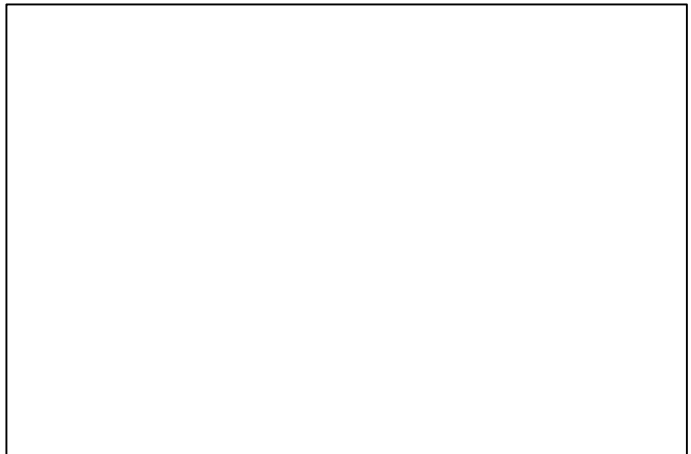

 Clancy Radiators Ltd.	REF No:	
	MODEL No:	
	CORE SIZE	
	CORE FORM	

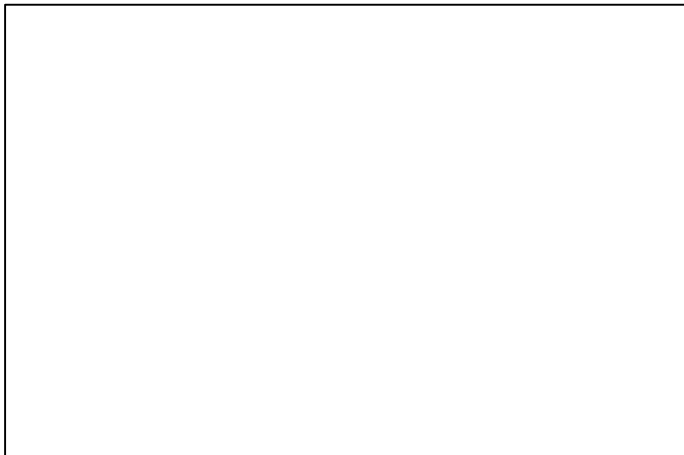

 Clancy Radiators Ltd.	REF No:	
	MODEL No:	
	CORE SIZE	
	CORE FORM	

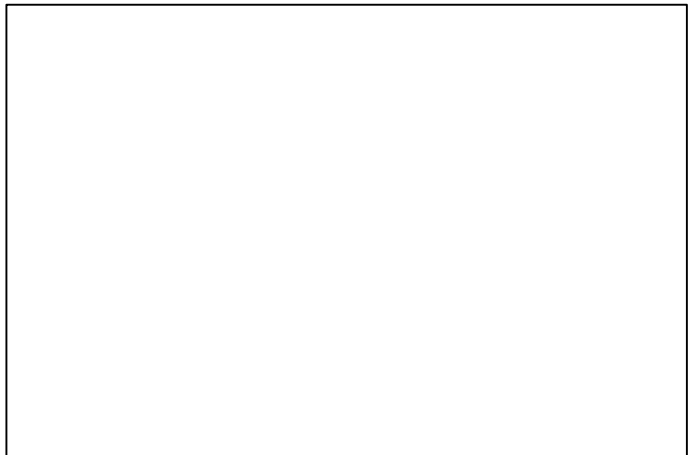

 Clancy Radiators Ltd.	REF No:	
	MODEL No:	
	CORE SIZE	
	CORE FORM	